

Techn. Daten: Catania

Bohlenaußenmaß (B x T): 576 x 300 cm

Wandaußenmaß: 556 x 280 cm · Bohlenstärke: 40 mm

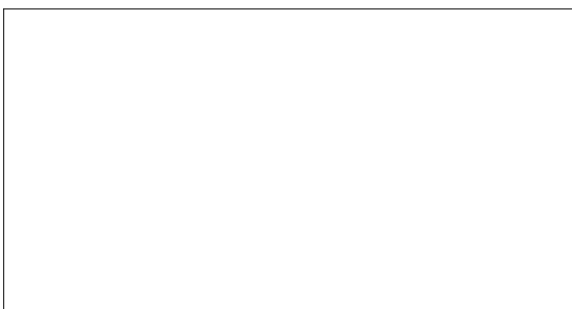

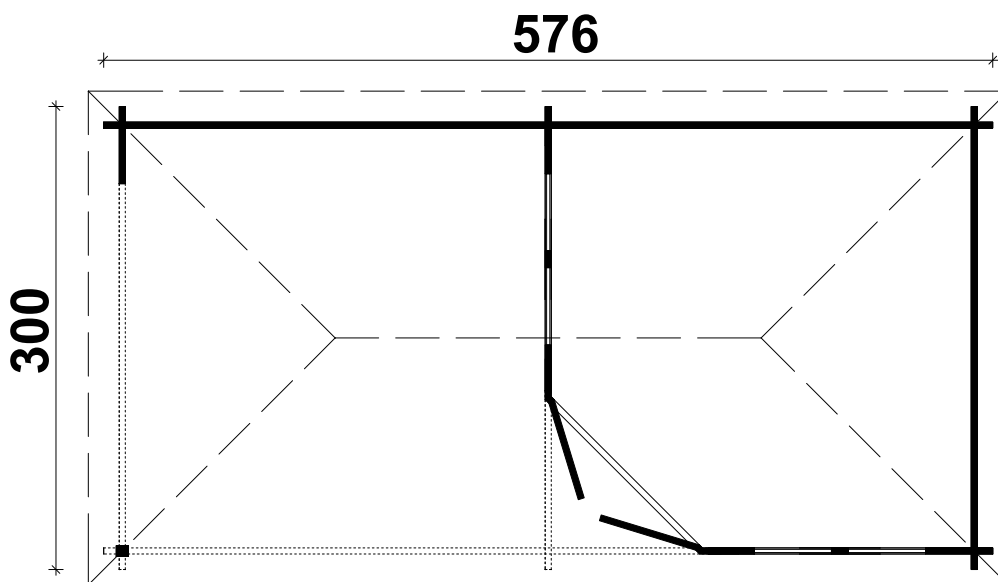



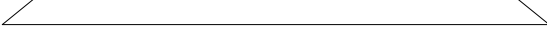

Achtung : Alle angegebenen Maße sind ca. - Maße !

Teileliste Catania 40 mm - 576 x 300 cm

| Nr | Beschreibung | Profil mm | Länge mm | Stück |
|-----|---|-----------|---------------|--------|
| 1 | | | 5760 | 1 |
| 2 | | | 1841 | 1 |
| 3 | | | 3000 | 21 |
| 4 | | | 3000 | 1 |
| 5 | | | 3000 | 1+1 |
| 6 | | | 5760 | 19 |
| 7 | | | 1841 | 8 |
| 8 | | | 435 | 24 |
| 9 | | | 296 | 24 |
| 10 | | | 1938 | 1+1 |
| 100 | | | 1841 | 1 |
| 11 | | | 500 | 17 |
| 12 | | | 5760 | 2 |
| 13 | | | 3000 | 1 |
| 14 | | | | 3000 |
| 15 | | 636 | | 4 |
| 16 | | | 614 | 4 |
| 17 | | | 428 | 4 |
| 18 | | | 897 | 4(2+2) |
| 19 | | | 1384 | 1(0+1) |
| 20 | | | 3352 | 1(1+0) |
| 21 | | 44x94 | 2364 | 4(2+2) |
| 22 | Dachbalken | 44x85 | 1739 | 10 |
| 23 | | 44x85 | 1265 | 8(4+4) |
| 24 | Kehlbalken | 18x90 | 2000 | 5 |
| 25 | Traufenbrett | 18x110 | 3250 | 2 |
| 26 | | | 5960 | 2 |
| 27 | Doppeltür 1425 x1900 mm Standart + | | | 1 |
| 28 | Einzelfenster 1100 x 1365 mm Standart + | | | 2 |
| 29 | Dachelemente h= 652 mm | | 1304 x 922 | 1 |
| 30 | Schrauben 4,0 x 40; 4,0 x 50; 5,0 x 70; 6,0 x 140 | | 160/700/90/70 | |
| 31 | Nägel 1,4 x 35 | | 25 | |
| 32 | Dachbretter | | 3191 | 2 |
| 33 | | | 2987 | 2 |
| 34 | | | 2783 | 2 |
| 35 | | | 2579 | 2 |

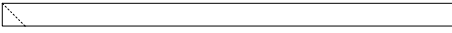
Teilleiste Catania 40 mm - 576 x 300 cm

| Nr | Beschreibung | Profil mm | Länge mm | Stück | | |
|----|--|---|---|---|------|------|
| 36 | Dachbretter  |  18x110 | 2375 | 2 | | |
| 37 | | | 2171 | 2 | | |
| 38 | | | 1968 | 2 | | |
| 39 | | | 1764 | 2 | | |
| 40 | | | 1560 | 2 | | |
| 41 | | | 1356 | 2 | | |
| 42 | | | 1152 | 2 | | |
| 43 | | | 948 | 2 | | |
| 44 | | | 744 | 2 | | |
| 45 | | | 540 | 2 | | |
| 46 | | | 337 | 2 | | |
| 47 | | | 133 | 2 | | |
| 48 | | | Dachbretter  |  18x110 | 5951 | 2 |
| 49 | | | | | 5747 | 2 |
| 50 | 5543 | 2 | | | | |
| 51 | 5340 | 2 | | | | |
| 52 | 5136 | 2 | | | | |
| 53 | 4932 | 2 | | | | |
| 54 | 4728 | 2 | | | | |
| 55 | 4524 | 2 | | | | |
| 56 | 4320 | 2 | | | | |
| 57 | 4116 | 2 | | | | |
| 58 | 3912 | 2 | | | | |
| 59 | 3709 | 2 | | | | |
| 60 | 3505 | 2 | | | | |
| 61 | 3301 | 2 | | | | |
| 62 | 3097 | 2 | | | | |
| 63 | 2893 | 2 | | | | |
| 64 | Fußbodenbretter *  |  18x110 | 1843 | 1 | | |
| 65 | | | 1953 | 1 | | |
| 66 | | | 2063 | 1 | | |
| 67 | | | 2173 | 1 | | |
| 68 | | | 2283 | 1 | | |
| 69 | | | 2393 | 1 | | |
| 70 | | | 2503 | 1 | | |
| 71 | | | 2613 | 1 | | |
| 72 | | | 2717 | -- | | |
| 73 | | | Fußbodenbretter  | | 2717 | 17+1 |

Step 2

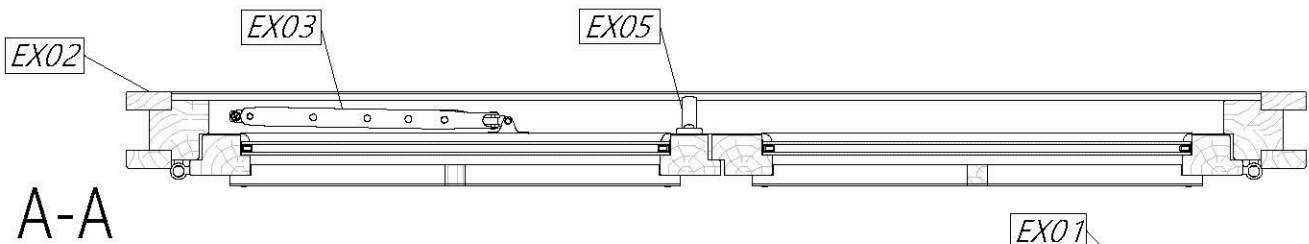
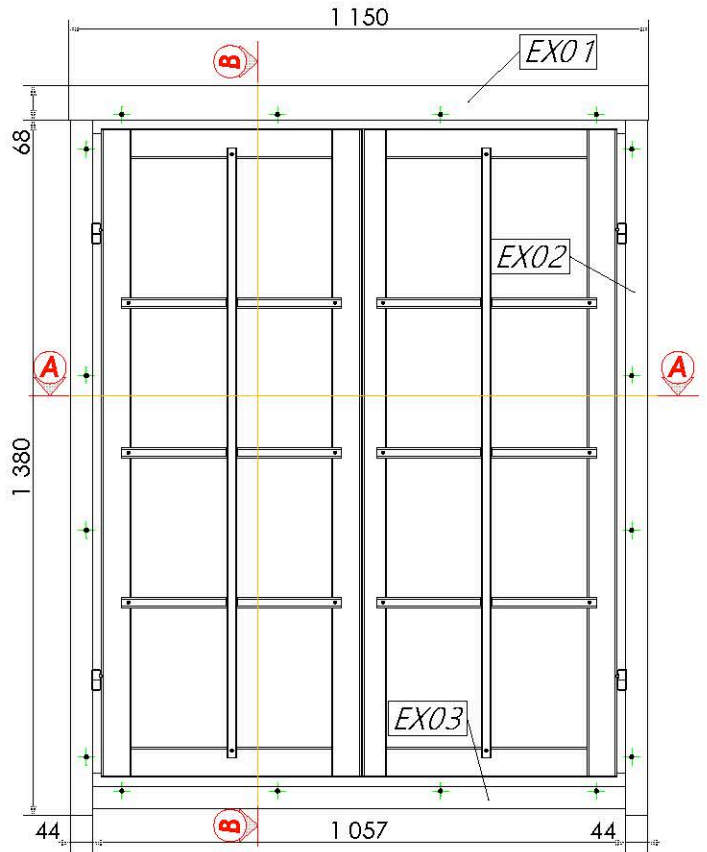
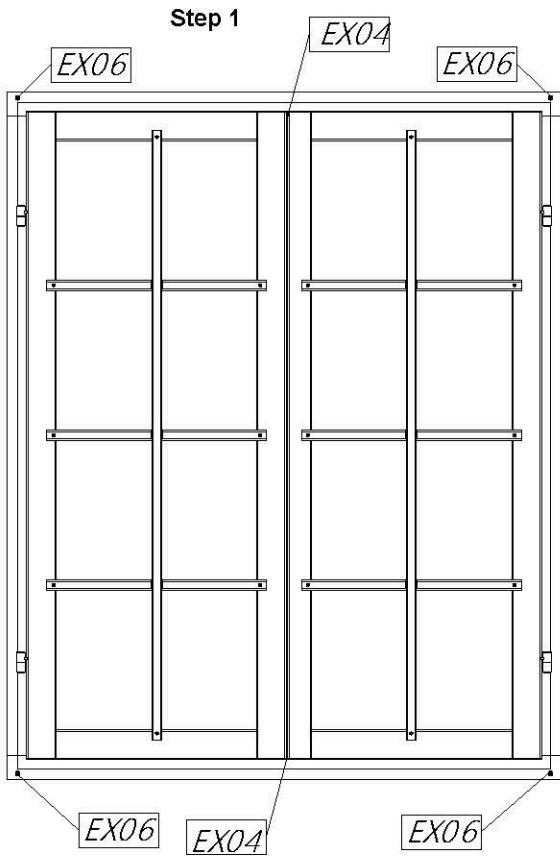





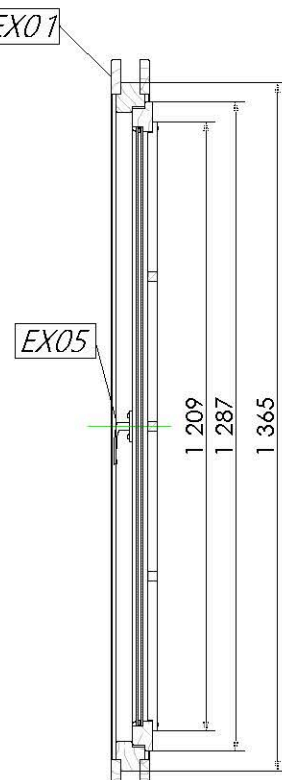

B-B

Step 3







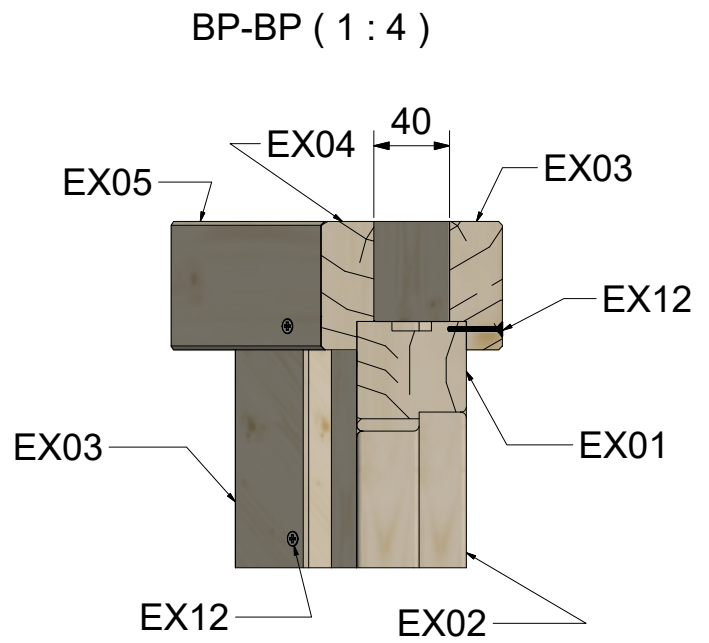
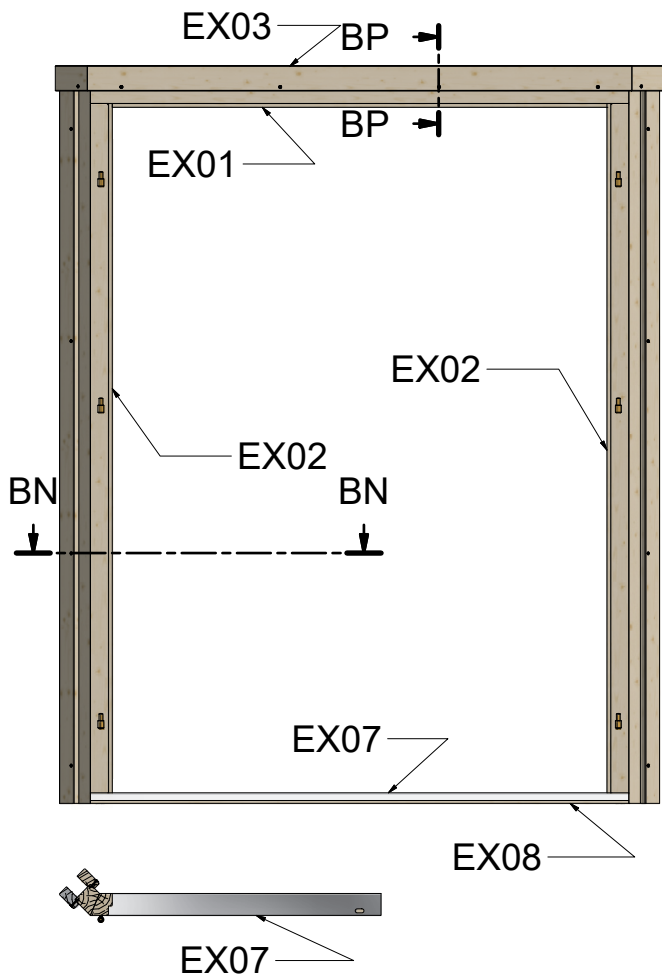

















Catania / Aruba / Sicilia / 1100 x 1365 mm Stand +/- 40 mm - R

| Nr. | Description | Profile mm | Length mm | Quantity |
|------|-----------------------------|---|-----------|----------|
| EX01 | Exterior- and interior trim |  | 1150 | 2 |
| EX02 | |  | 1380 | 4 |
| EX03 | |  | 1057 | 2 |
| EX04 | |  | 14 x 26 | 2 |
| EX05 | Handle |  | | 1 |
| EX06 | Screws 4,0 x 40 |  | | 36+2 |
| EX06 | Window Clamp |  | | 1 |

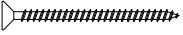

Specification Double Door Frame 40mm

| Nr | Description | Profile | Amount |
|------|---|---|-------------|
| EX01 |  |  | 1 |
| EX02 |  |  | 1+1 |
| EX03 |  |  | 1 |
| EX04 |  |  | 1 |
| EX05 |  |  | (1+1)+(1+1) |
| EX06 |  |  | 4 |
| EX07 |  |  | 1 |
| EX08 |  |  | 1 |
| EX09 |  |  | 1 |
| EX10 | Screws 5,0 x 70  | | 4 |
| EX11 | Screws 4,0 x 50  | | 2 |
| EX12 | Screws 4,0 x 40  | | 28 |
| EX13 | Screws 3,0 x 30  | | 2 |

Double Door Frame 40

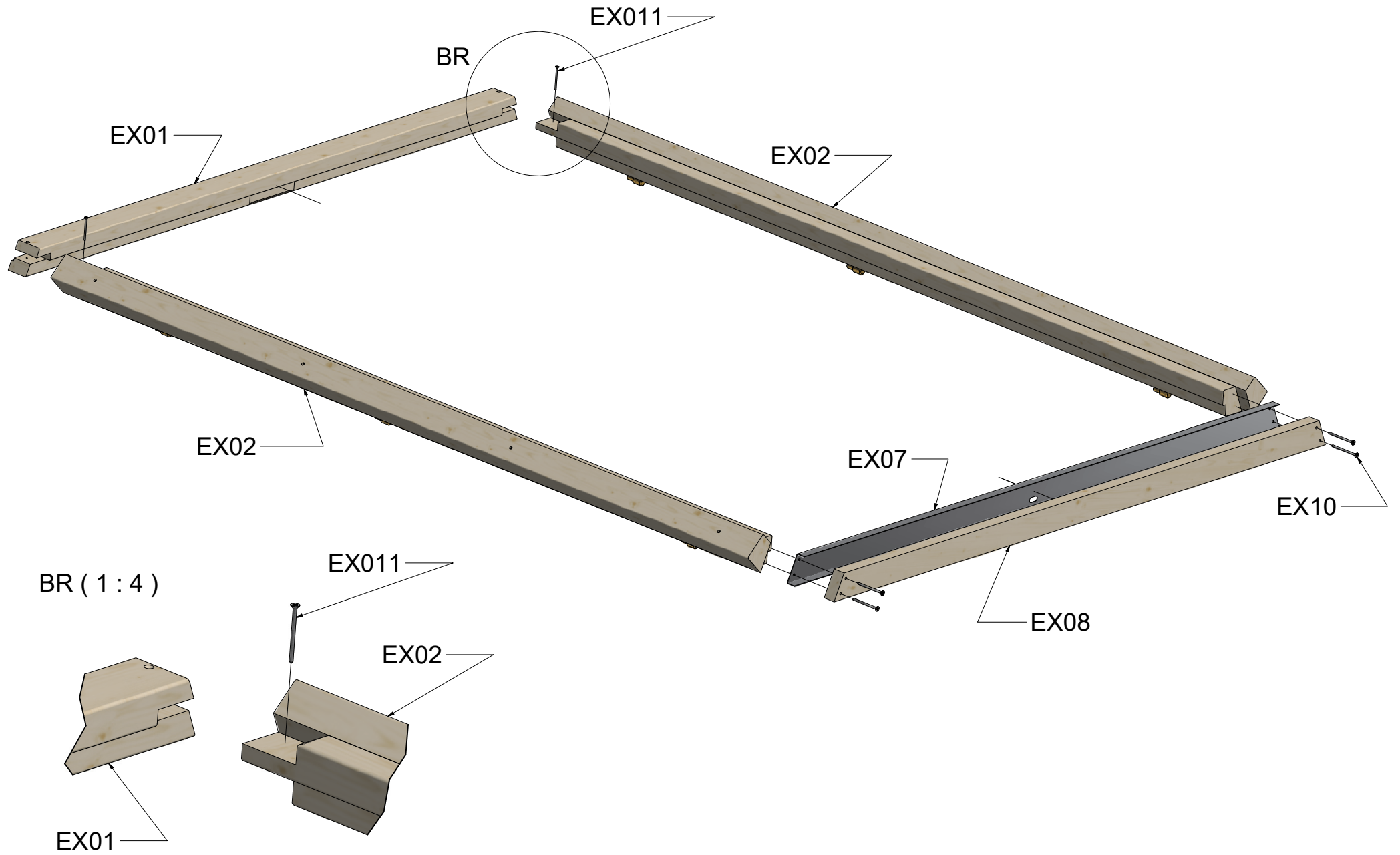

Double Door Frame 40

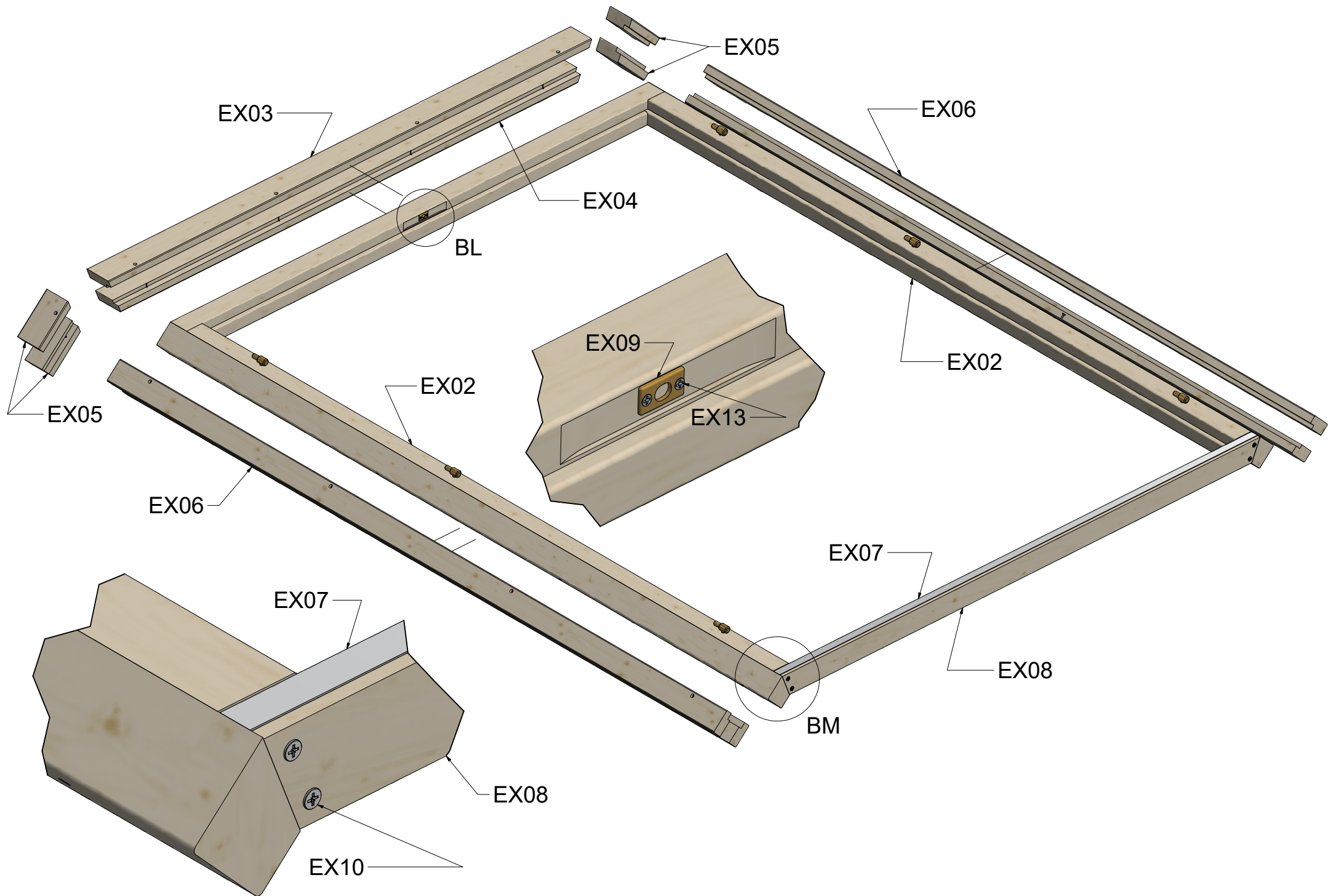

Wandplan Catania 40 mm - 576 x 300 cm - Fundamentplan

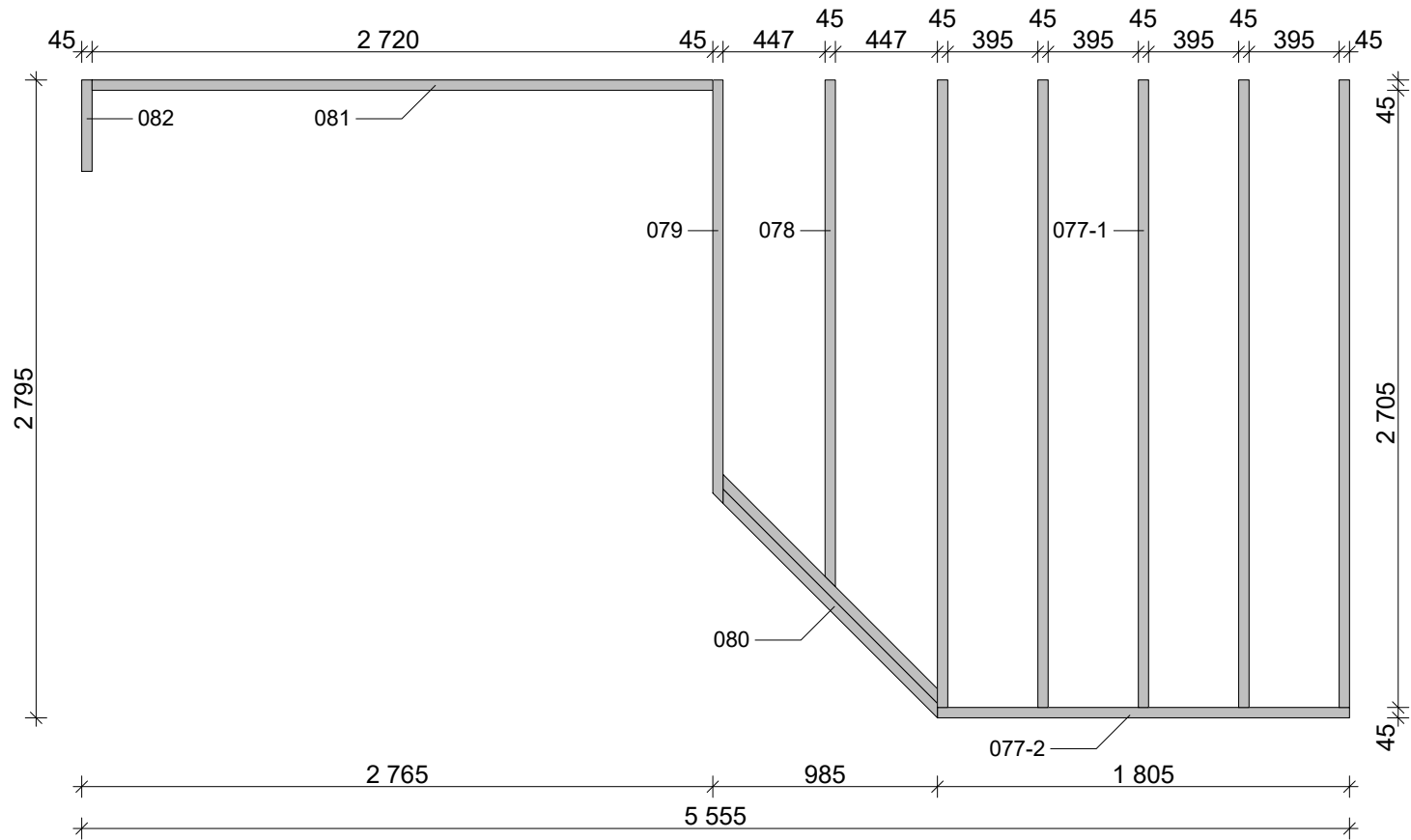

Wandplan Catania 40 mm - 576 x 300 cm - Wandplan

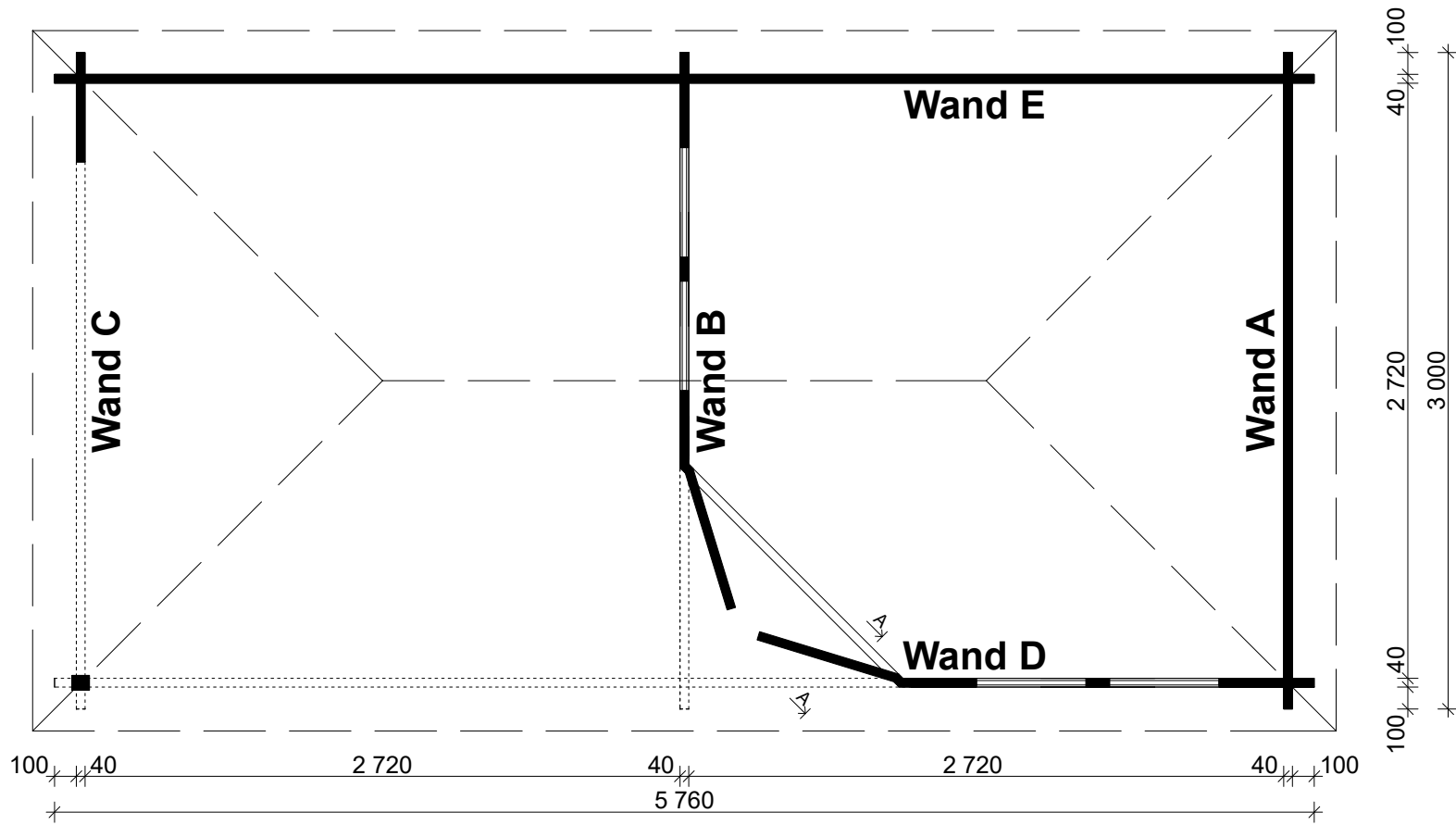

Wandplan Catania - 576 x 300 cm

Wand A

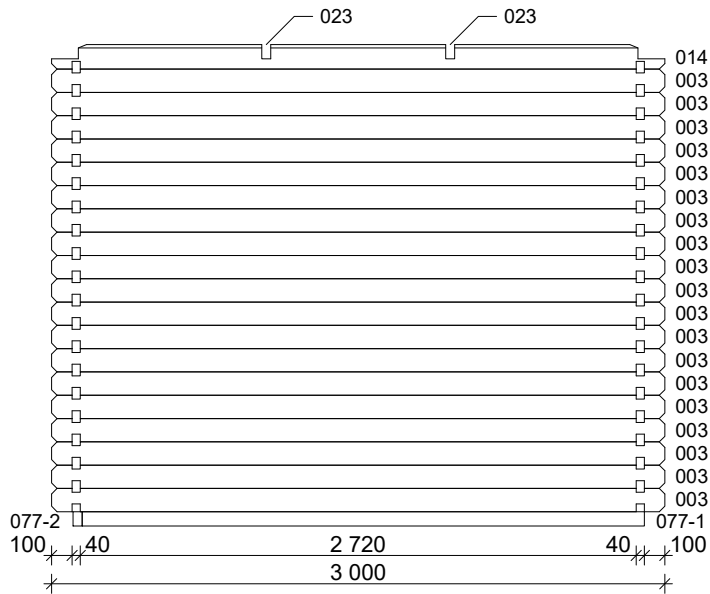

Wand B

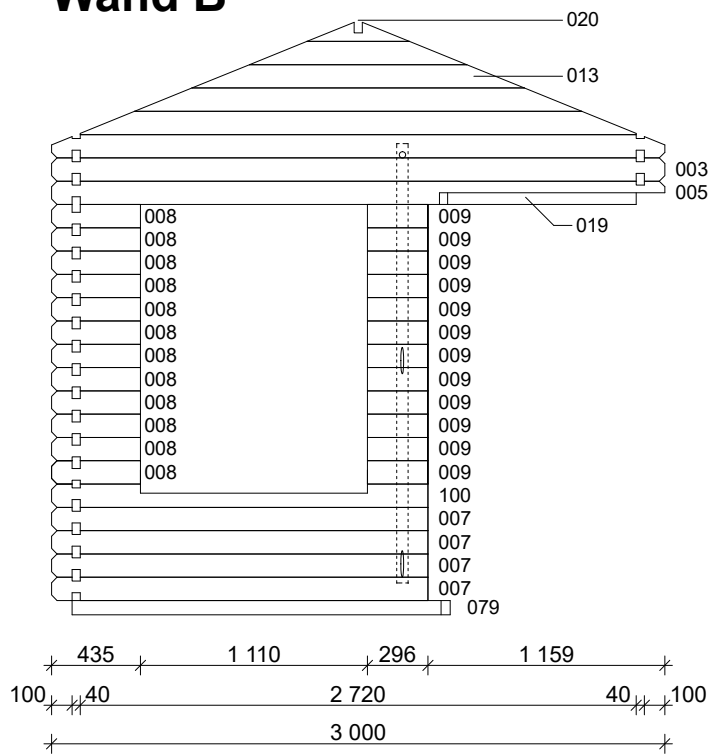

Wandplan Catania - 576 x 300 cm

Wand C

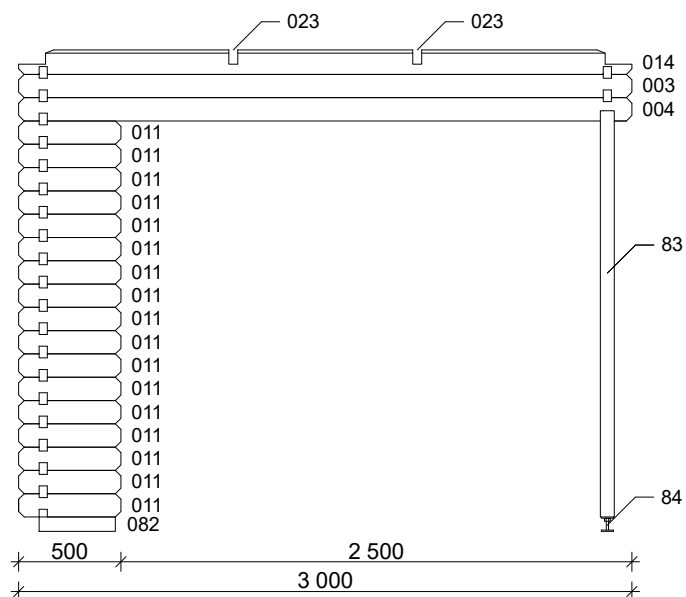

Nr. 27

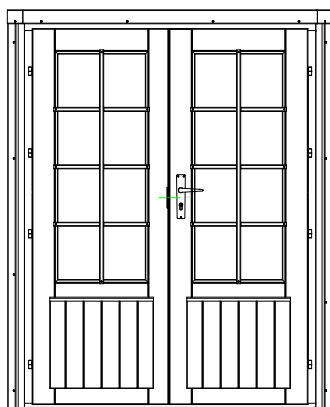

Doppeltür 40 mm
1425 x 1900 mm
1 stk.

Nr. 28

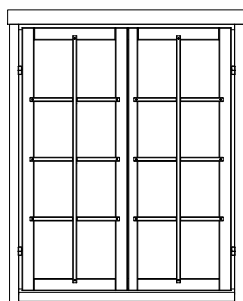

Fenster 40 mm
1100 x 1365 mm
2 stk.

A - A

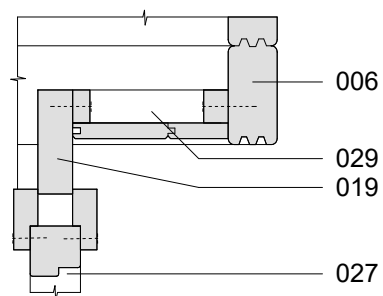

Wandplan Catania - 576 x 300 cm

Wand D

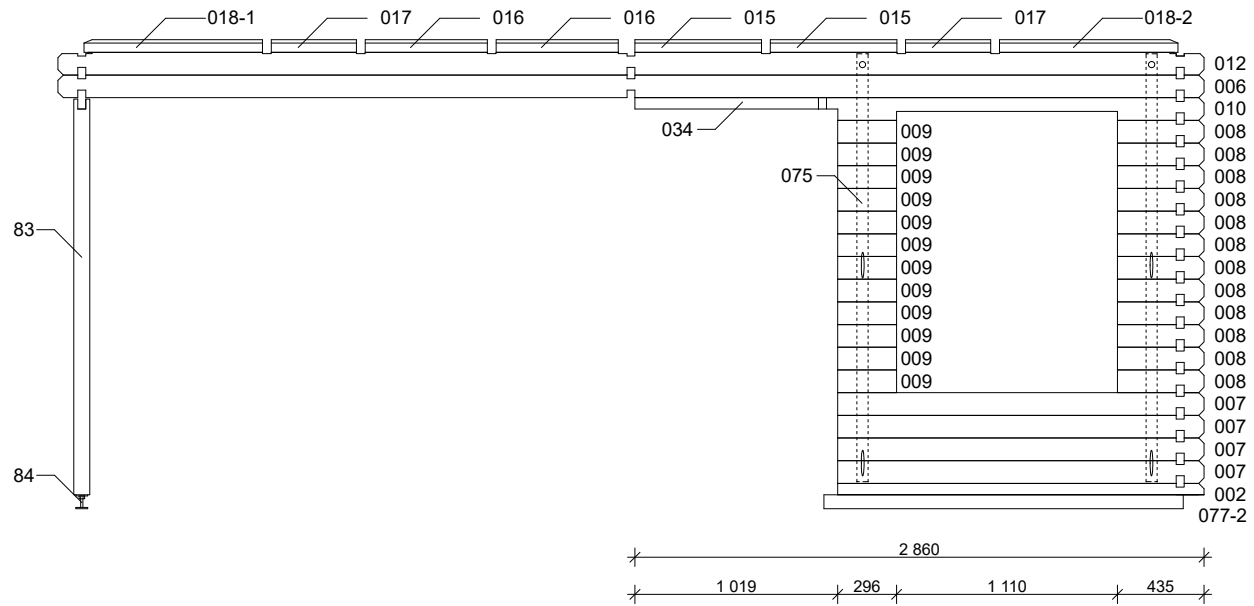

Wand E

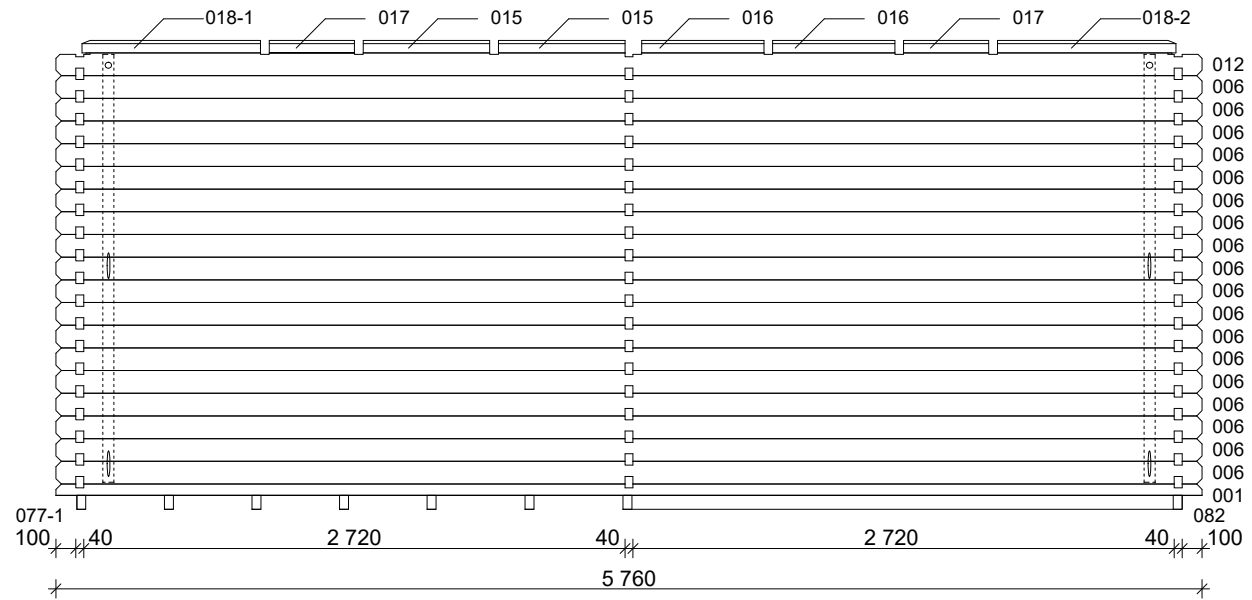

Wandplan Catania 40 mm - 576 x 300 cm - Dachplan

